



**High Voltage Energy Storage System
Battery HV5120-S Series Product Manual**











This manual introduces HV5120-S from FEB. Please read this manual before you install the battery and follow the instruction carefully during installation process. Please contact FEB immediately for advice and clarification if you have any question.

Contents

Catalogue

1.Symbol Description.....	3
2.Safety Precautions	4
2.1 Before Connecting	4
2.2 In Using	4
3.Introduction	5
3.1 Features.....	5
3.2 Specification	6
3.3 Equipment interface instruction	7
4.Safe Handling of Lithium-iron ESS Batteries Guide	12
4.1 Solution Diagram.....	12
4.2 Danger Label	12
4.3 Tool.....	12
4.4 Safety Gear	13
5.Installation and operation	14
5.1 Package items	14
5.2 Installation Location	15
5.3 Installation Direction	15
5.4 Installation Steps.....	16
5.5 System turns on.....	19
5.6 System turns off.....	20
6.Emergency Situations.....	20
6.1 Battery Leakage	20
6.2 On Fire.....	20
6.3 Wet Batteries	20
6.4 Damaged Batteries.....	20
7.Remarks.....	21
7.1 Recycle and Disposal.....	21
7.2 Maintenance.....	21
7.3 Declaration of conformity.....	21

1. Symbol Description

	Do not place near open fire or flammable materials.
	A potential hazard exists when the equipment is working. Wear personal protective equipment during operation.
	Warning electric shock. Power off the equipment before any operation.
	Grounding: indicate PE cable connection position.
	Do not place in areas accessible to children.
	Keep the battery away from open fire or ignition sources.
	Read the product and operation manual before operating the battery system.
	Label for Waste Electrical and Electronic Equipment (WEEE) Directive (2012/19/EU)
	The certificate label for CE.
	Recycle label.

2. Safety Precautions



Alert

- 1) It is important and necessary to read the user manual carefully (and attachment) before installing or using battery. Failure to do so or to follow any instruction or warning in this document can result in electrical shock, serious injury, and death, or damage battery, potentially rendering it unusable.
- 2) When battery is stored for a long time, it is required to charge once every 6 months, and the SOC should be no less than 85%.
- 3) After battery module cannot be discharged, it needs to be recharged within 12h.
- 4) Do not connect power terminal reversely.
- 5) All power supplies must be disconnected during maintenance.
- 6) Please contact the supplier within 24 hours if there is something abnormal.
- 7) Do not use any liquid to clean the battery.
- 8) Do not expose battery to flammable or irritating chemicals or vapor.
- 9) Do not paint any part of battery, including any internal or external components.
- 10) Do not connect battery with PV solar wiring directly.
- 11) Do not install or use this product beyond provisions of the manual.
- 12) Direct or indirect damages caused by the above reasons are not covered by warranty claim.



Warning

2.1 Before Connecting

- 1) Please check the external packaging condition before unpacking. If it is damaged, contact corresponding local retailer.
- 2) After unpacking, please check the products and spare parts according to spare parts list. If the product is damaged or missing, please contact your local retailer.
- 3) Connect to specified matching inverter.
- 4) Before installation, be sure to cut off the grid power and make sure battery is in turned-off mode.
- 5) It is prohibited to connect the battery and AC power directly.
- 6) Embedded BMS in the battery is designed for 24VDC.
- 7) All electrical wiring must be connected in accordance with local regulations.
- 8) Please ensure that electrical performance of battery system is compatible with the equipment.
- 9) The installation onsite shall be equipped with fire-fighting facilities that meet relevant requirements, such as fire sand, dry powder fire extinguisher, etc.

2.2 In Using

- 1) If battery system needs to be moved or repaired, power must be cut off and battery is completely shut down.
- 2) It is prohibited to connect battery with different types of battery.

- 3) Do not connect battery to faulty inverter.
- 4) In case of fire, only dry powder fire extinguisher can be used, liquid fire extinguishers are prohibited
- 5) Do not open, repair or disassemble the battery except Far East Battery personnel or other authorized personnel. The company shall not bear any liability or responsibility caused by violation of any safety operation or design standard, production standard, equipment safety standards or any other standards or requirements.

3.Introduction

HV5120-S energy storage system battery is a new energy storage product developed and produced by FEB, which can provide reliable power supply for all kinds of equipment or systems.



Figure 3-1

3.1 Features

- 1) Built-in soft-start function to reduce current impact.
- 2) When multiple modules are series connected, module addresses are set automatically.
- 3) Support for upgrading the battery module from the upper controller through CAN communication.
- 4) The module is non-toxic, non-polluting and environmentally friendly.
- 5) Cathode material is made from LiFePO4 with safety performance and long cycle life.
- 6) Battery management system (BMS) has protection functions including over- discharge, over-charge, over-current and high/low temperature.
- 7) The system can automatically manage charge and discharge state and balance voltage of each cell.
- 8) Flexible configuration, multiple battery modules can be connected to expand capacity and power.
- 9) Adopted self-cooling mode rapidly reduced system entire noise
- 10) The module has less self-discharge, up to 6 months without charging it on shelf, no memory effect, excellent performance of shallow charge and discharge

Functions

Protection and Alarm	Management and monitor
Charge/Discharge End	Cell Balance

Overvoltage Charging Protection	Intelligent Charge Model
Under Voltage Discharging Protection	Charge/Discharge Current Limit
Charge/Discharge Overcurrent Protection	Capacity Retention Calculate
High/Low Temperature Protection	Soft start
Short Circuit Protection	History Record

3.2 Specification

Parameters

No.	Items	Specification
1	Product Name	Rechargeable Lithium Iron Phosphate Module
2	Module Model	HV5120-S1
3	Battery Type	LFP 1P32S
4	Nominal Capacity	5.12kWh
5	Usable Capacity	4.86kWh (95% DOD)
6	Nominal Voltage	102.4V
7	Working Voltage	91.2~115.2V
8	Charging Voltage	112V
9	Max. Charge Current	25A
10	Max. Discharge Current	40A
11	Communication	RS485 , CAN
12	Storage Temperature	-20°C ~ 50°C (0 ~ 45°C (Recommended))
13	Storage Humidity	≤85% (RH)
14	Working Temperature	Charging: 0°C ~ 50°C Discharging: -20°C ~ 50°C
15	Working Humidity	≤95% (RH) No Condensation
16	Working Altitude	≤2000m
17	Ingress Protection	IP55
18	Protective Class	I
19	Weight	~45kg
20	Dimension	636mm*330mm*188mm
21	Design Life	15 Years (25°C)
22	Cycle Life	> 6000 (25°C) ,60% EOL
23	Scalability	Module: Max. 8S
24	Certification	IEC62619, IEC63056, CE EMC, UN38.3

Dimensions

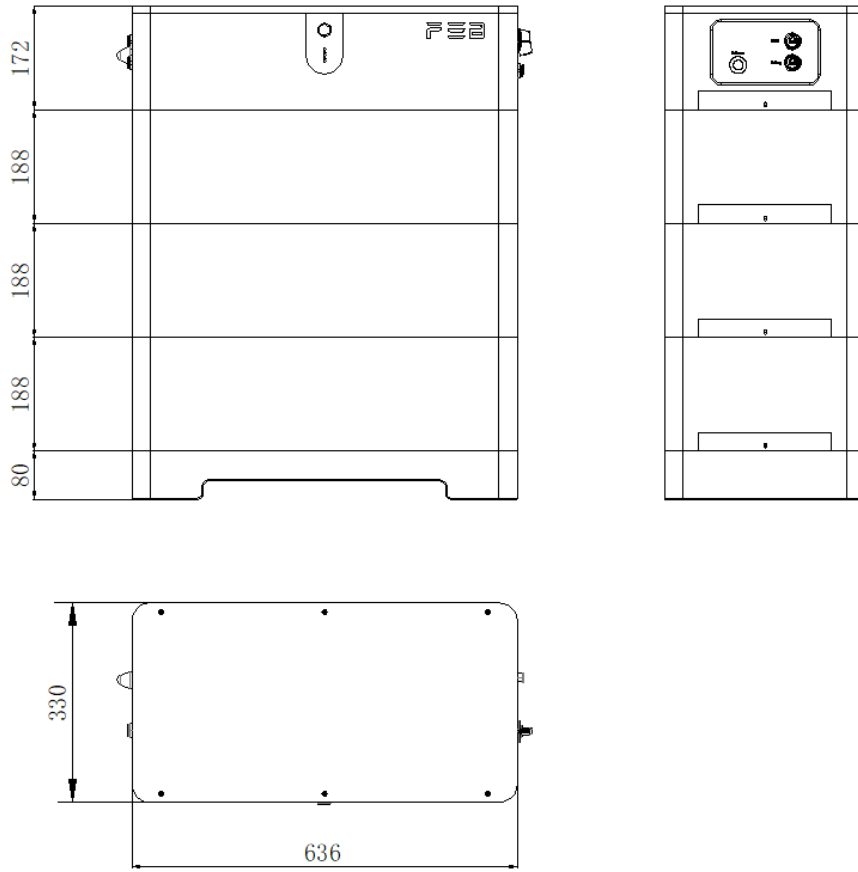

Figure 3-2

3.3 Equipment interface instruction

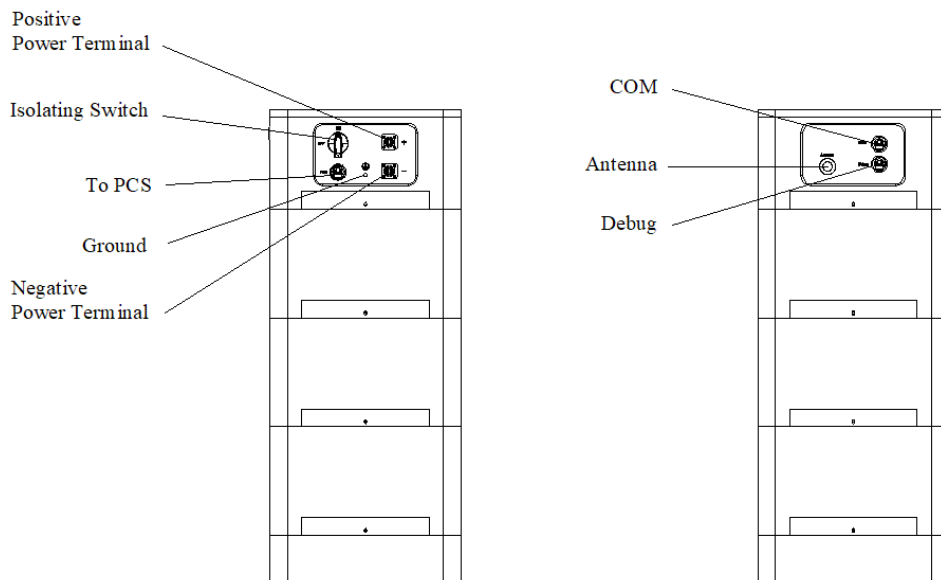

Figure 3-3

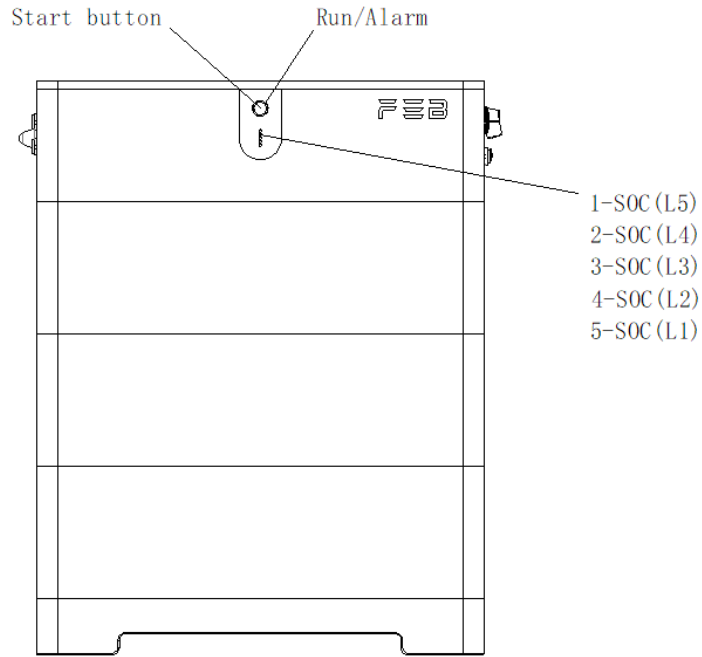

Figure 3-4

Start

Turn on: When battery is dormant, press the START button to start the battery module.

Black start: Press and hold the button for 10s to turn on the battery for black start.

Run/Alarm

Blue LED lighting to show the battery system is running or having alarm.

Status	Mode	Run/Alarm	Remark
Power off	Power off		Light is off
Run	Standby/Charge/Discharge		Light is on
Alarm	Level I Alarm		System can run, but there will be alarm tips
	Level II Alarm		System will stop, and check the problem

Note

Description of indicator light



The indicator light is off.



The indicator light is on



The indicator light is flashing. Duration of indicator on is 0.25s, Duration of indicator off is 3.75s.



The indicator light is flashing. Duration of indicator on is 0.5s, Duration of indicator off is 1.5s.

SOC

Green LEDs are used to show the battery's remaining capacity.

State		Charging/Discharging				
		L5	L4	L3	L2	L1
Capacity Indicator LED						
SOC	0 ~ 20%	○	○	○	○	○ ³
	20 ~ 40%	○	○	○	○ ³	●
	40 ~ 60%	○	○	○ ³	●	●
	60 ~ 80%	○	○ ³	●	●	●
	80 ~ 95%	○ ³	●	●	●	●
	95 ~ 100%	●	●	●	●	●

Note

- The SOC indicator light is off.
- The SOC indicator light is on.
- ³ The SOC indicator light is flashing, Duration of indicator on is 0.5s, Duration of indicator off is 0.5s.

Isolating Switch

When you rotate the Isolating Switch to ON position, Positive Power Terminal will connect with the HV+ battery contactor and Negative Power Terminal will connect with the battery HV-, on the other hand, when Isolating Switch is at OFF position both connection will off.

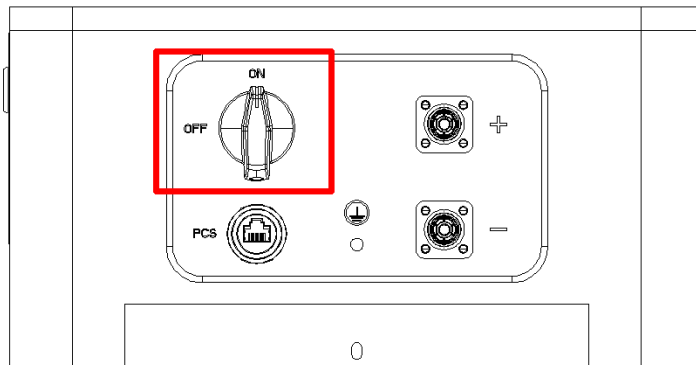

Figure 3-5

Power Terminal

Power cable terminals: there are two pairs of terminals with same function, one connects to equipment, the other one paralleling to other battery module for capacity expanding.

For power cables uses water-proofed connectors. Must keep pressing this Lock Button while pulling out the power plug.



Figure 3-6

To PCS

Be used to communicate with inverter or upper battery.

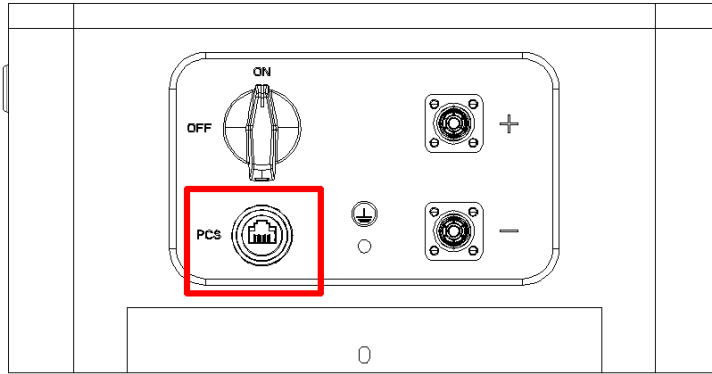
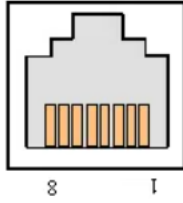

Figure 3-7

RJ45 Socket



Pin	Definition
1	RS485-1A
2	RS485-1B
3	Undefined
4	CAN3-H
5	CAN3-L
6	Undefined
7	CAN1-H
8	CAN1-L

RS485-1: Communication with PCS by RS485

CAN3: Communication with PCS by CAN

CAN1: Master/slave communication channel

COM

CAN communication port with upper computer or display monitor.

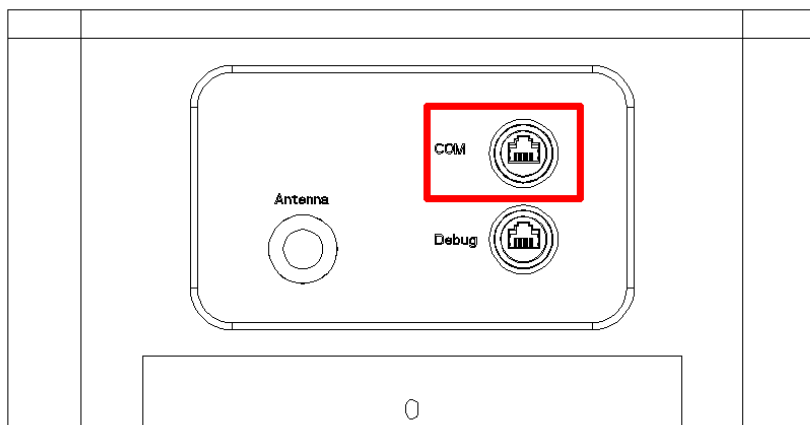
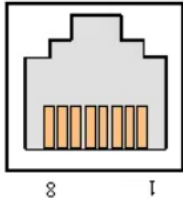

Figure 3-8

RJ45 Socket



Pin	Definition
1	24V-
2	ADDR_DO
3	Undefined
4	Undefined
5	Undefined
6	Undefined
7	CAN2H
8	CAN2L

ADDR_DO: Output signal for Master BCU to arrange the address.

24V- : 24V- signal

CAN communication: CAN bus for each rack and upper computer or display monitor. (CAN2H CAH2L).

Debug

For battery debug usage.

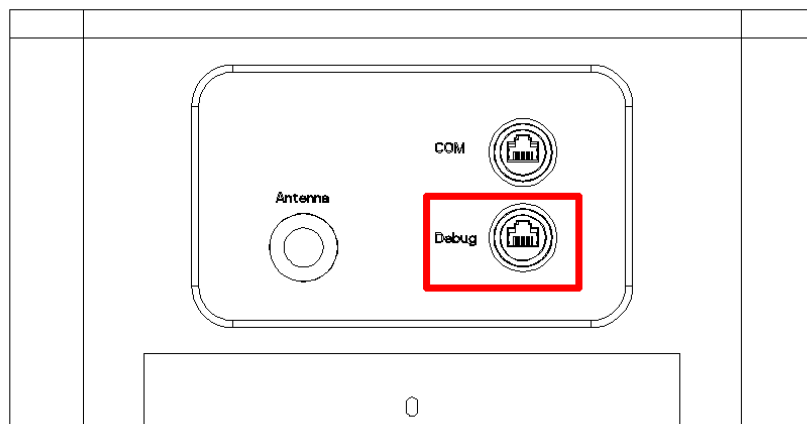
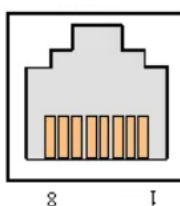

Figure 3-9

RJ45 Socket



Pin	Definition
1	24V-
2	ADDR_DI
3	Master Address DI
4	RS485-2B
5	RS485-2A
6	Undefined
7	24V-
8	24V+

24V: DC Input (Pin8 connect with 24V+, Pin1&pin7 connect with 24V-).

Master Address DI: For Master rack to arrange the address.

RS485-2: communication: RS485 for each rack and upper computer or display monitor (RS485-2A RS485-2B).

4. Safe Handling of Lithium-iron ESS Batteries Guide

4.1 Solution Diagram

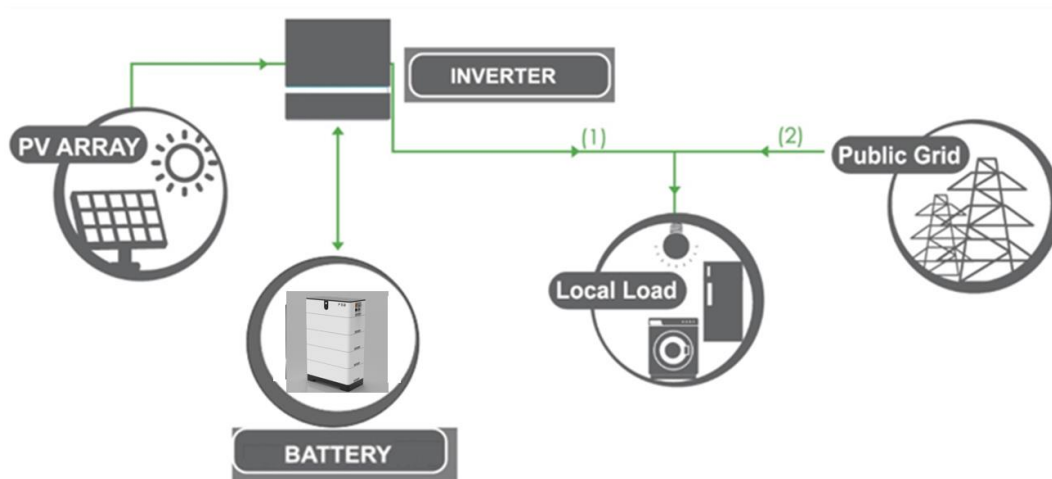

Figure 4-1

4.2 Danger Label

DANGER
DANGER LOW DCVOLTAGE INSIDE
DANGER ARC FLASH & SHOCK HAZARD

- * Do not disconnect or disassemble by non-professional personnel.
- * Do not drop, deform, impact, cut or spearing with a sharp object.
- * Do not place near open flame or flammable material.
- * Do not cover or wrap the product case.
- * Do not touch the leaking liquid.
- * Beware of high temperature.
- * Avoid of direct sunlight.
- * Follow the product manual to make wiring connection.
- * If leaking, fire, wet or damaged, switch off the breaker on DC side and stay away from battery.
- * Contact your supplier within 24 hours if anything failure happens.

Figure 4-2

4.3 Tool



Wire Cutter



Modular Crimping Plier



Screwdriver



Electric drill

Note

Properly use insulated tools to prevent accidental electric shock or short circuits. If tools are not insulated, cover the entire exposed metal surfaces of available tools with electrical tape except their tips.

4.4 Safety Gear

It is recommended to wear the following safety gear when dealing with battery pack.



Insulated Gloves



Safety Goggles



Safety Shoes

5. Installation and operation

5.1 Package items

Unpacking and check the Package items

1) For battery module package:

- Battery Module

2) For packing box of high voltage box:

NOTE: Power and communication cables connect to inverter belongs to the packing box of high voltage box.

- 2 * 2000mm 6AWG power cables
- 1 * 3000mm RJ45 communication cable
- 1 * 3000mm 10AWG grounding cable



Figure 5-1

5.2 Installation Location

Make sure that installation location should meet the following condition:

- 1) The area should be completely water-proof.
 - 2) The floor should be flat and level.
 - 3) No flammable or explosive materials.
 - 4) The ambient temperature is within the range from 0°C to 45°C.
 - 5) The temperature and humidity are maintained at a constant level.
 - 6) There is just a little dust and dirt in the area.
 - 7) The distance from heat source should be more than 2 meters.
 - 8) The distance from air outlet of inverter is more than 0.5 meters.
 - 9) Installation areas should avoid direct sunlight.
 - 10) No forced ventilation requirement for battery module, but please avoid installing in a closed area.
- Ventilation shall avoid high salinity $\leq 30\%$, humidity $\leq 85\%$ and ambient temperature of 0 ~ 45 °C.

5.3 Installation Direction

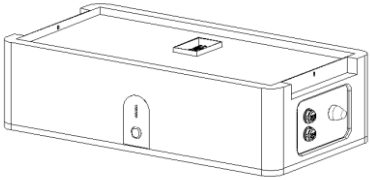
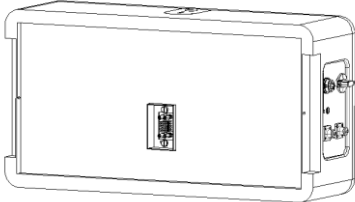
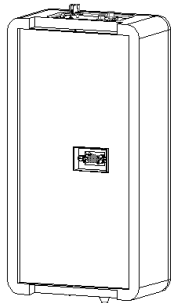
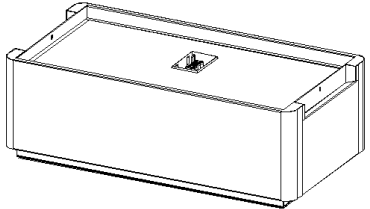
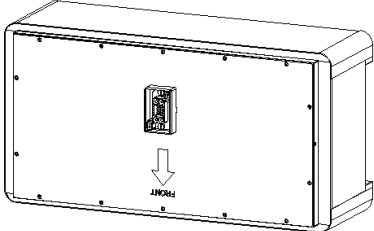
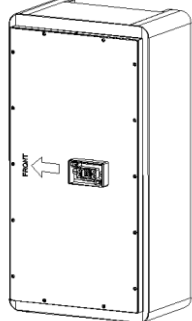

Warning

Upside down	Sidelong	Sidelong
		
		

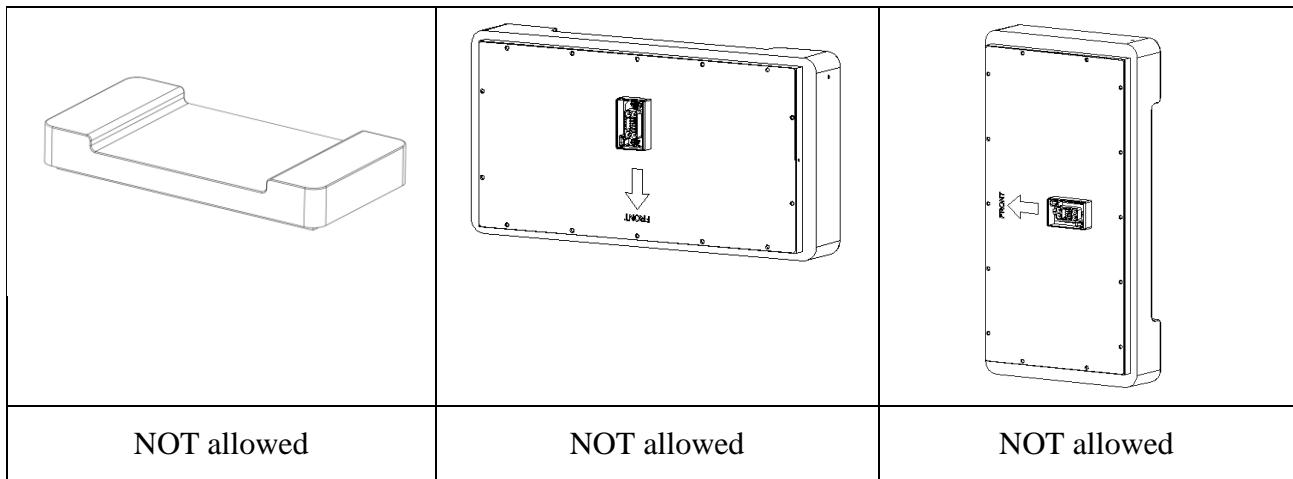

Figure 5-2

5.4 Installation Steps



Warning

- 1) Follow local electric safety and installation policy, a suitable breaker between battery system and inverter is required.
- 2) All installation and operation must follow local electric standard and requirements.
- 3) When battery modules are paralleled, the system should be powered off before installation operation

1. Install the brackets to the base of the battery rack using 2 pcs M4*10 socket head cap screws with locking torque of 2.5N•m.

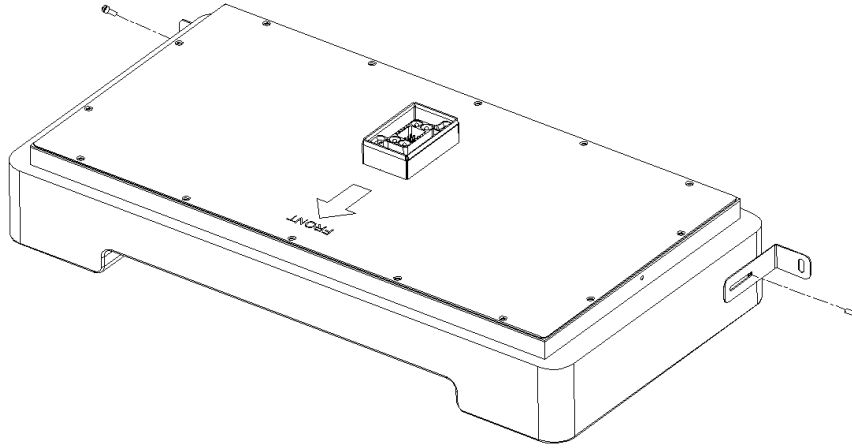

Figure 5-3

2. Install the brackets to the HV Box of the battery rack using 2 pcs M4*10 socket head cap screws with locking torque of 2.5N•m.

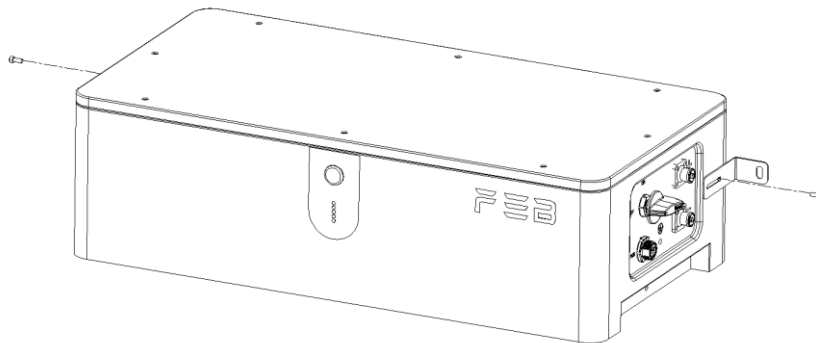

Figure 5-4

3. Place the base against the wall and mark the position of mounting holes on the wall. Remove the base and drill holes using an electric drill. The electric drill must with a dust cover to prevent dust from falling off.

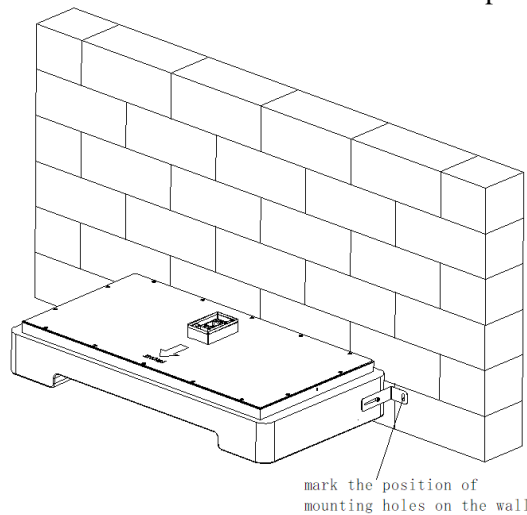

Figure 5-5



Figure 5-6

4. Place the base against the wall and fix the base to the wall with position of mounting holes on the wall with 2 pcs M6 expansion screws by 8N•m.

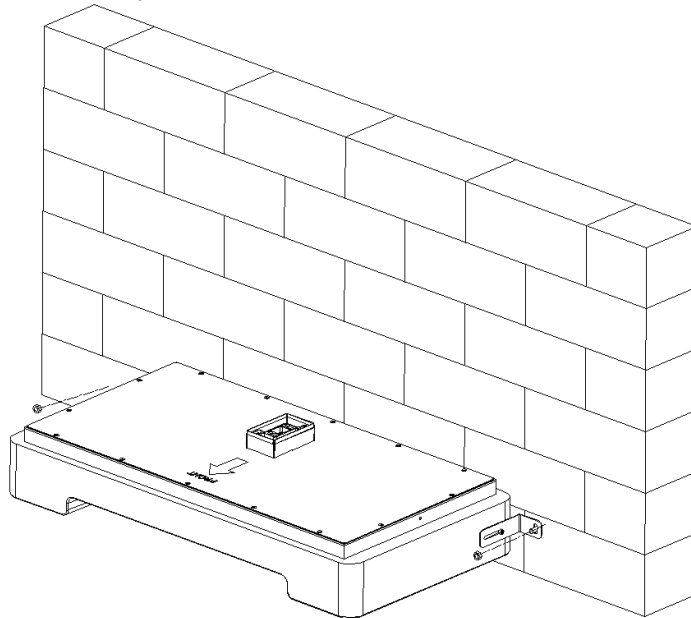

Figure 5-7

5. Then lay the battery module one by one on the base, and fix all the M4*8 sunk screws on the left side and right side(each module have 4 fixed point)by 2N•m.

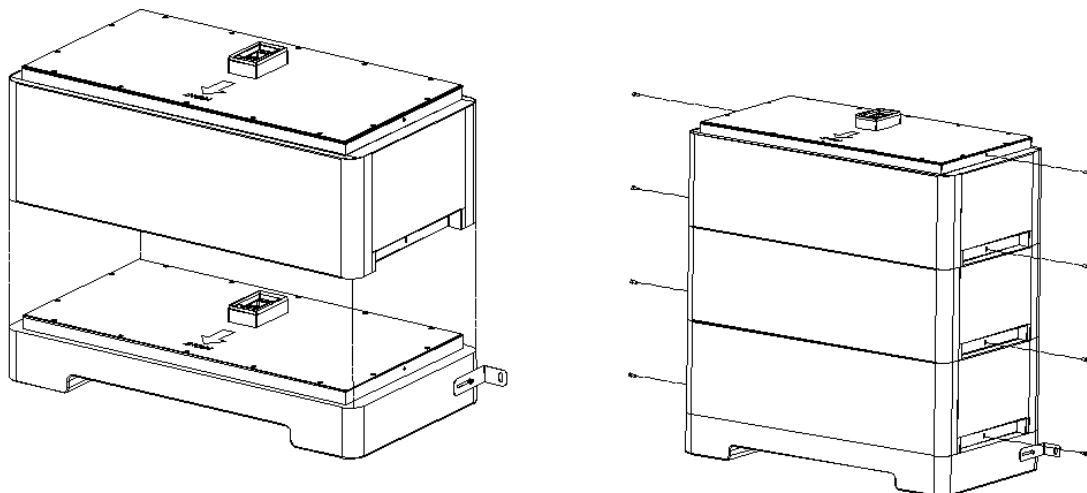

Figure 5-8

6. Place the HV box on the top of the module and mark the position of mounting holes on the wall. Remove the HV box and put a dust cover over the top of the module and then drill holes using an electric drill to prevent dust from falling off. Place the HV box back and fix the base to the wall with position of mounting holes on the wall with 2 pcs M6 expansion screws by 8N•m.

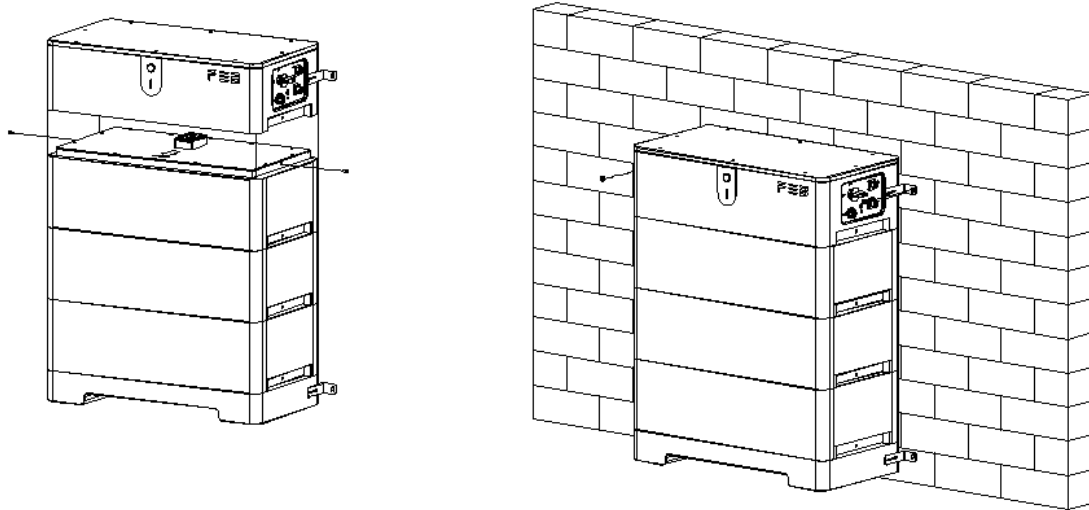

Figure 5-9

7. Connect the ground cable, power cable and communication cable between PCS and battery rack .

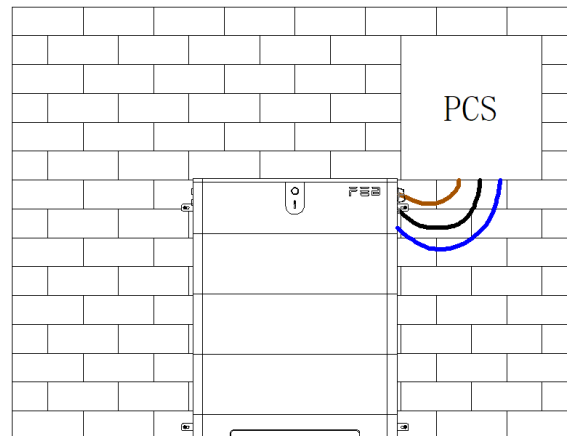

Figure 5-10

5.5 System turns on

Warning: Double check all the power cables and communication cables. Make sure the voltage of the inverter/PCS is same level with the battery system before connection. Check all the power switches are OFF.

System turns on step:

- 1) Check all cables are connected correctly. Check grounding is connected.
- 2) If necessary, turn on the switch at inverter`s battery side or between inverter and battery. If possible, turn on AC or PV power source to wake up inverter.
- 3) Open protect cover of Power switch. And turn on power switch.
- 4) Switch all the battery racks` Isolating Switch to on position.
- 5) Press the battery START button in turn, turn on the START metal button of the slave battery firstly, and finally turn on the START button of the master battery (1 master battery rack and 7 slave battery racks at most can be configured).
- 6) If no alarm ,the battery system will be ready for charging and discharge with PCS

5.6 System turns off

When failure or before service, must turn the battery storage system off:

- 1) Turn off inverter or power supply on DC side.
- 2) Turn off the switch between PCS and battery system.
- 3) Switch Isolating Switch to off position. (Switch off the slave battery firstly, finally switch off the master battery)

Note

- 1) One battery system shall just have one master, all the others are slaves. (The one on the extreme side connected to inverter is the master battery.)
- 2) It is forbidden to switch off the Isolating Switch during charging and discharging.

6. Emergency Situations

6.1 Battery Leakage

If the battery pack leaks electrolyte, avoid contact with the leaking liquid or gas. If one is exposed to the leaked substance, immediately perform the actions described below

- 1) Inhalation: Evacuate contaminated area and seek medical aid.
 - 2) Contact with eyes: Rinse eyes with flowing water for 15 minutes and seek medical aid.
 - 3) Contact with skin: Wash affected area thoroughly with soap water and seek medical aid.
- Ingestion: Induce vomiting and seek medical aid.

6.2 On Fire

NO WATER!

Only dry powder fire or carbon dioxide extinguisher can be used; if possible, move the battery module to a safe area before it catches fire.

6.3 Wet Batteries

If the module is wet or submerged in water, do not let people access it, then contact FAR EAST BATTERY or an authorized dealer for technical support. Cut off all power switch on inverter side.

6.4 Damaged Batteries

Damaged batteries are dangerous and must be handled with utmost care. They are not fit for use and may pose a danger to people or property. If the module seems to be damaged, pack it in its original container, then return it to authorized dealer.



Warning

Damaged batteries may leak electrolyte or produce flammable gas.

7. Remarks

7.1 Recycle and Disposal

In case a battery (normal condition or damaged) needs disposal or needs recycling, it shall follow the local recycling regulation (i.e. Regulation (EC) N° 1013/2006 among European Union) to process, and using the best available techniques to achieve a relevant recycling efficiency.



7.2 Maintenance

- 1) It is required to charge the battery at least once every 6 months, for this charge maintenance make sure the SOC is charged to higher than 85%.
- 2) Check installation environment such as dust, water, insect etc. Make sure it is suitable for IP20 battery system. Connection of power connector, grounding point, power cable and screw are suggested to be checked every year

7.3 Declaration of conformity

The battery system described in this document complies with the applicable European directives. The certificate is available in the download area of our websites.



Far East Battery Jiangsu Co., Ltd

No. 8, Keji Avenue, Gaocheng Town, Yixing City,
Wuxi City, Jiangsu Province, P.R. China

<http://en.febattery.com/>

service.feb@feseglobal.com.cn